

MPW-54

MPW-55

MPW-56



PDF



v.1



### Wirówki MPW-54, MPW-55, MPW-56

są serią małych, wentylowanych, stołowych wirówek laboratoryjnych przeznaczonych do podstawowych zastosowań i przygotowania próbek. Przy minimalnych gabarytach zapewniają prostotę obsługi pozwalając na szybkie i dokładne rozdzielanie mieszanin, zawiesin, płynów ustrojowych, próbek biologicznych lub innych na składniki o różnych gęstościach pod wpływem działania siły odśrodkowej. Zostały zaprojektowane specjalnie z myślą o potrzebach niewielkich laboratoriów medycznych lekarzy rodzinnych, przychodni i klinik weterynaryjnych, gabinetów medycyny estetycznej do pozyskiwania PRP i PRF, ortopedii, pracowni parazytologicznych, naukowych i innych, w których niejednokrotnie wiruje się od jednej do kilku próbek jednocześnie.

**MPW-54, MPW-55 and MPW-56 centrifuges** are a series of small, ventilated, table laboratory centrifuges, intended for basic applications and sample preparation. With minimal dimensions they provide the ease of use, allowing for quick and accurate separation of mixtures, suspensions, body fluids, biological samples or other components with different densities under the influence of the centrifugal force. They were designed specifically for the needs of small medical laboratories for family doctors, veterinary clinics and aesthetic medicine cabinets for the acquisition of PRP and PRF, orthopaedics, parasitological, scientific and other laboratories, in which you can often centrifuge from one to several tubes at the same time.



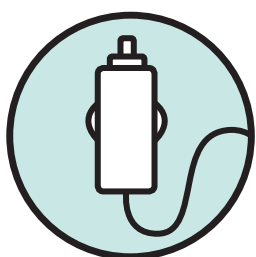

Las centrifugas MPW-54, MPW-55, MPW-56 son una serie de centrifugas de laboratorio pequeñas, ventiladas, de mesa para aplicaciones básicas y preparación de las muestras. Con sus dimensiones mínimas proporcionan la operación fácil permitiendo separar, debido a la fuerza centrífuga, mezclas, suspensiones, fluidos corporales, muestras biológicas y otras en componentes de distintas densidades de manera rápida y precisa. Se han diseñado pensando en necesidades de pequeños laboratorios de médicos de cabecera, consultorios y clínicas veterinarias, centros de medicina estética para obtener PRP y PRF, ortopedia, laboratorios de parasitología, científicos y otros donde muchas veces se centrifugan de una a varias muestras al mismo tiempo.



możliwość zasilania wirówki z gniazda zapalniczki samochodowej [przetwornica 12V DC/230V AC] [MPW-55, MPW-56]

power may be supplied from a car lighter socket [12V DC/230V AC converter] [MPW-55, MPW-56]

opción de alimentar la centrifuga desde la toma de mechero en coche [convertidor de 12V CC/230V CA] [MPW-55, MPW-56] consecetur adipiscing elit, sed

	MPW-54	MPW-55	MPW-56
	230V 50/60Hz; 120 50/60Hz [opcja: <a href="#">option</a> ; opción 100, 110, 127V 50/60Hz]	100 ÷ 230V 50/60Hz	100 ÷ 230V 50/60Hz
	60 W	95 W	70 W
	120 ml	48 ml	120 ml
	3 500, 5 800 lub/or/o 1 000 <sup>2</sup> , 3 500 <sup>2</sup> RPM	100 ÷ 14 500 RPM, krok/step/paso 100 RPM	100 ÷ 6 000 RPM, krok/step/paso 100 RPM
RCF max.	1 137, 3 122 lub/or/o 93 <sup>2</sup> , 1 137 <sup>2</sup> x g	15 279 x g	3 341 x g
	1 ÷ 30 min +, ∞, krok/step/paso 1s	15s ÷ 99min 45s + ∞, krok/step/paso 15s	15s ÷ 99min 59s, ∞, krok/step/paso 1s
	180 x 220 x 270mm [HxWxD]	180 x 220 x 270mm [HxWxD]	180 x 220 x 270mm [HxWxD]
	4 kg	5 kg	4 kg
Cat. No.	10054/2-56 [230V 50/60Hz] 10054/1-56 [120V 50/60Hz]	10055/12-56 [100÷230V 50/60Hz]	10056/12-56 [100÷230V 50/60Hz]

CECHY	FEATURES	CARACTERÍSTICAS
Wirówki zaprojektowane ze szczególnym uwzględnieniem potrzeb lekarzy rodzinnych oraz weterynarzy	Centrifuges designed according to specific needs of family physicians and veterinarians	Centrifugas diseñadas teniendo en cuenta las necesidades de médicos de cabecera y veterinarios
bezobsługowy silnik indukcyjny [MPW-55, MPW-56]	maintenance-free induction motor [MPW-55, MPW-56]	motor de inducción sin mantenimiento [MPW-55, MPW-56]
możliwość zasilania wirówki z gniazda zapalniczki samochodowej [przetwornica 12V DC/230V AC] [MPW-55, MPW-56]	power may be supplied from a car lighter socket [12V DC/230V AC converter] [MPW-55, MPW-56]	opción de alimentar la centrifuga desde la toma de mechero en coche [convertidor de 12V CC/230V CA] [MPW-55, MPW-56]
nowoczesny układ programowania [MPW-55]	modern software system [MPW-55]	sistema de programación moderno [MPW-55]
intuicyjny układ nastawiania parametrów wirowania [MPW-56]	intuitive setting of spinning parameters [MPW-56]	sistema intuitivo de ajuste de los parámetros de centrifugado [MPW-56]
wyświetlacz LED [MPW-54]	LED display [MPW-54]	pantalla LED [MPW-54]
wyświetlacz LCD [MPW-55, MPW-56]	LCD display [MPW-55, MPW-56]	pantalla LCD [MPW-55, MPW-56]
9 programów użytkownika [MPW-55]	9 user programs [MPW-55]	9 programas de usuario [MPW-55]
2 prędkości wirowania [MPW-54]	2 centrifuging speeds [MPW-54]	2 velocidades de centrifugado [MPW-54]
regulacja RPM/RCF [MPW-55, MPW-56]	RPM/RCF adjustment [MPW-55, MPW-56]	ajuste de RPM/RCF [MPW-55, MPW-56]
1 charakterystyka rozpędzania/hamowania [MPW-54, MPW-56]	1 acceleration/deceleration curve [MPW-54, MPW-56]	1 característica de aceleración/desaceleración [MPW-54, MPW-56]
3 charakterystyki rozpędzania/hamowania [MPW-55]	3 acceleration/deceleration curves [MPW-55]	3 características de aceleración/desaceleración [MPW-55]
regulacja czasu wirowania	centrifugation time adjustment	ajuste del tiempo de centrifugado
tryb pracy ciągłej HOLD [MPW-54, MPW-55]	continuous operation mode HOLD [MPW-54, MPW-55]	modo de funcionamiento continuo - HOLD [MPW-54, MPW-55]
praca w trybie SHORT [MPW-55]	SHORT time operation mode [MPW-55]	funcionamiento en modo SHORT [MPW-55]
małe gabaryty	small size	pequeñas dimensiones
BEZPIECZEŃSTWO	SAFETY	SEGURIDAD
czujnik niewyważenia [MPW-55]	unbalance sensor [MPW-55]	sensor de desequilibrio [MPW-55]
blokada pokrywy podczas wirowania	lid locking during rotor running	bloqueo de la tapa durante la centrifugación
blokada startu przy otwartej pokrywie	start blocking at opened lid	bloqueo del inicio con la tapa abierta
awaryjne otwieranie pokrywy	emergency lid lock release	apertura de emergencia de la tapa
produkt zgodny z normami EN-61010-1 i EN-61010-2-020, EN-61010-2-101	product conforming with the EN-61010-1 and EN-61010-2-020, EN-61010-2-101 standards	este producto cumple con las normas EN-61010-1 i EN-61010-2-020, EN-61010-2-101

<sup>2</sup> Na specjalne zamówienie. [On special request.](#) Para un encargo especial.









Φ x L [mm]	16x100	13x100	13x75	11x66; 11x92; 13x75; 13x85; 15x92; 15x75; 16x92	10,8x41,8	6x21; 7,3x7,72	10,2x37,2	6x21,6
	Blood collection Vacutainer® Vacuette®	Blood collection Vacutainer® Vacuette®	Blood collection Vacutainer® Vacuette®	Blood collection S-Monovette®	Eppendorf® Snap Cap	PCR	PCR	PCR
	2,5-11; 7-9 ml	3,5-6; 4-7 ml	1-4,5; 1,6-5,3 ml	1,6-10 ml	1,5/2ml	8x0,2 ml	4x0,2 ml	0,2 ml

MPW-54	MPW-55	MPW-56		RCF max.		REF
•	-	-	5 800	3 121	6 x 15/10ml	11101
-	-	•	6 000	3 341	6 x 15/10ml	11140
-	-	•	6 000	3 341	8 x 15/10ml	11141
•	-	-	5 800	3 122	4 x 15/10ml	11144
•	-	-	5 800	3 122	8 x 15/10ml	11145
-	•	•	MPW-55: 14 500 MPW-56: 6 000	MPW-55: 13 163 MPW-56: 2 254	[2x4/2x8] x 0,2ml PCR	11201
-	•	•	MPW-55: 14 500 MPW-56: 6 000	MPW-55: 15 279 MPW-56: 2 616	12 x 2/1,5ml	11202
-	•	-	MPW-55: 14 500 MPW-56: 6 000	MPW-55: 15 279 MPW-56: 2 616	24 x 2/1,5ml	11204
-	•	-	14 500	14 574	24 kapilary/ capillaries 50mm	12205



9 programów użytkownika [MPW-55]  
 9 user programs [MPW-55]  
 9 programas de usuario [MPW-55]



					
0,5 ml	15 ml	15; 10 ml	14; 10; 6 ml	0,019 ml	10; 7; 5 ml
PCR	Falcon®	Nalgene®	plastic type	capillaries	glass type
7,8x31	17x120	16x81,5; 16x113;	11,5x92; 16x106; 16,8x113; 7; 17x70;	1,3x50	12x75; 12x100; 16x100;
6	6	6	6		6
6	6	6	6		6
4	8	8	8		8
4	4	4	4		4
4	8	8	8		8
12					
24					
				24	

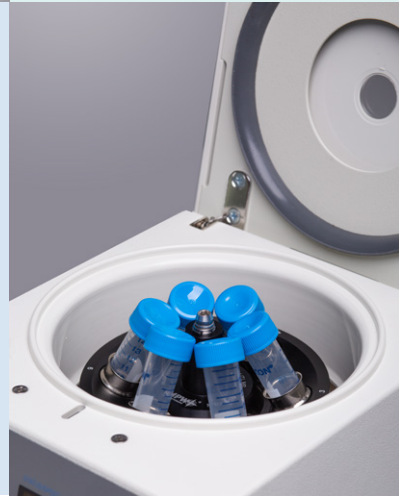
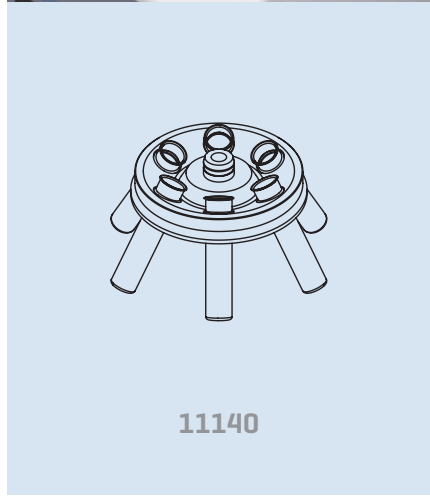

**3 charakterystyki rozpędzania/hamowania [MPW-55]**

**3 acceleration/deceleration curves [MPW-55]**

**3 características de aceleración/desaceleración [MPW-55]**

Zastrzega się prawo do zmian. MPW MED. INSTRUMENTS nie ponosi odpowiedzialności za ewentualne błędy drukarskie. Technical specification subject to change. MPW MED. INSTRUMENTS is not responsible for printing mistakes. Se reserva el derecho a introducir cambios. MPW MED. INSTRUMENTS no asume responsabilidad de eventuales errores tipográficos. Falcon® jest zarejestrowanym znakiem towarowym firmy Corning Incorporated, NY, USA. Falcon® is a registered trademark of Corning Incorporated, NY, USA. Falcon® es la marca registrada de Corning Incorporated, NY, EEUU. Nalgene® jest zarejestrowanym znakiem towarowym firmy Nalge Nunc International Corporation, Rochester, USA. Nalgene® es la marca registrada de Nalge Nunc International Corporation, Rochester, EEUU. S-Monovette® jest zarejestrowanym znakiem towarowym firmy Sarstedt AG & Co. S-Monovette® is a registered trademark of Sarstedt AG & Co. S-Monovette® es la marca registrada de Sarstedt AG & Co. Eppendorf® jest zarejestrowanym znakiem towarowym firmy Eppendorf AG. Eppendorf® is a registered trademark of Eppendorf AG. Eppendorf® es la marca registrada de Eppendorf AG. Vacuette® jest zarejestrowanym znakiem towarowym firmy Greiner Bio-One. Vacuette® is a registered trademark of Greiner Bio-One. Vacuette® es la marca registrada de Greiner Bio-One. Vacutainer® jest zarejestrowanym znakiem towarowym firmy Becton Dickinson. Vacutainer® is a registered trademark of Becton Dickinson.

	S-LINE				M-LINE			
	<b>MPW-54</b>	<b>MPW-55</b>	<b>MPW-56</b>	<b>MPW-150R</b>	<b>M-UNIVERSAL</b>	<b>M-DIAGNOSTIC</b>	<b>M-SCIENCE</b>	<b>MPW-260</b>
	120 ml	48 ml	120 ml	90 ml	500 ml	500 ml	100 ml	500 ml
RCF max.	1 137, 3 122 x g	15 279 x g	3 341 x g	21 382 x g	24 270 x g	4 830 x g	24 270 x g	24 270 x g
RPM max.	3 500, 5 800	14 500	6 000	15 000	18 000	6 000	18 000	18 000
	-	-	-	-20°C + +40°C	-	-	-	-
Liczba wirników (kątowych horyzontalnych) Number of rotors (angleswing-out) Numero de rotores (angularoscilante)	3/0	4/0	5/0	8/0	20/5	9/7	9/0	18/4
Autoidentyfikacja wirnika Rotor auto-recognition Identificación de rotores automática	-	-	-	•	•	•	•	•
Język Language Idioma	EN	EN	EN	PL, EN, ES, IT, PT, DE, RU, SE, FR, CZ	PL, EN, ES, IT, PT, DE, RU, SE, FR, CZ	PL, EN, ES, IT, PT, DE, RU, SE, FR, CZ	PL, EN, ES, IT, PT, DE, RU, SE, FR, CZ	PL, EN, ES, IT, PT, DE, RU, SE, FR, CZ
Dociąganie pokrywy Cover tightening Ajuste de la cubierta	-	-	-	-	-	-	-	-
Programy użytkownika User programs Programas de usuario	-	9	-	100	100	100	100	100
	M-LINE		L-LINE				XL-LINE	
	<b>MPW-260R</b>	<b>MPW-260RH</b>	<b>MPW-351e</b>	<b>MPW-352</b>	<b>MPW-352R</b>	<b>MPW-352RH</b>	<b>MPW-380</b>	<b>MPW-380R</b>
	500 ml	500 ml	800 ml	1 000 ml	1 000 ml	1 000 ml	3 000 ml	3 000 ml
RCF max.	24 270 x g	24 270 x g	3 509 x g	30 065 x g	30 065 x g	30 065 x g	31 876 x g	31 876 x g
RPM max.	18 000	18 000	4 500	18 000	18 000	18 000	18 000	18 000
	-20°C + +40°C	-20°C + +55°C	-	-	-20°C + +40°C	-20°C + +55°C	-	-20°C + +40°C
Liczba wirników (kątowych horyzontalnych) Number of rotors (angleswing-out) Numero de rotores (angularoscilante)	18/4	18/4	2/2	25/6	25/6	25/6	13/3	13/3
Autoidentyfikacja wirnika Rotor auto-recognition Identificación de rotores automática	•	•	-	•	•	•	•	•
Język Language Idioma	PL, EN, ES, IT, PT, DE, RU, SE, FR, CZ	PL, EN, ES, IT, PT, DE, RU, SE, FR, CZ	EN	PL, EN, ES, IT, PT, DE, RU, SE, FR, CZ	PL, EN, ES, IT, PT, DE, RU, SE, FR, CZ	PL, EN, ES, IT, PT, DE, RU, SE, FR, CZ	PL, EN, ES, IT, PT, DE, RU, SE, FR, CZ	PL, EN, ES, IT, PT, DE, RU, SE, FR, CZ
Dociąganie pokrywy Cover tightening Ajuste de la cubierta	-	-	-	•	•	•	•	•
Programy użytkownika User programs Programas de usuario	100	100	-	100	100	100	100	100

ul. Boremlowska 46  
04-347 Warszawa Polska  
46 Boremlowska Street  
04-347 Warsaw Poland  
Calle Boremlowska 46  
04-347 Varsovia Polonia



**MPW MED. INSTRUMENTS**  
www.mpw.pl

E-mail: mpw@mpw.pl  
Phone: +48 22 610 56 67  
Phone: +48 22 740 20 25  
Fax: +48 22 610 81 01



European Union  
European Regional  
Development Fund

